

	REV: A
Author: Brad Campbell	
Date: 4/15/14 4:03 PM	Sheet: 1/1

2014/04/28

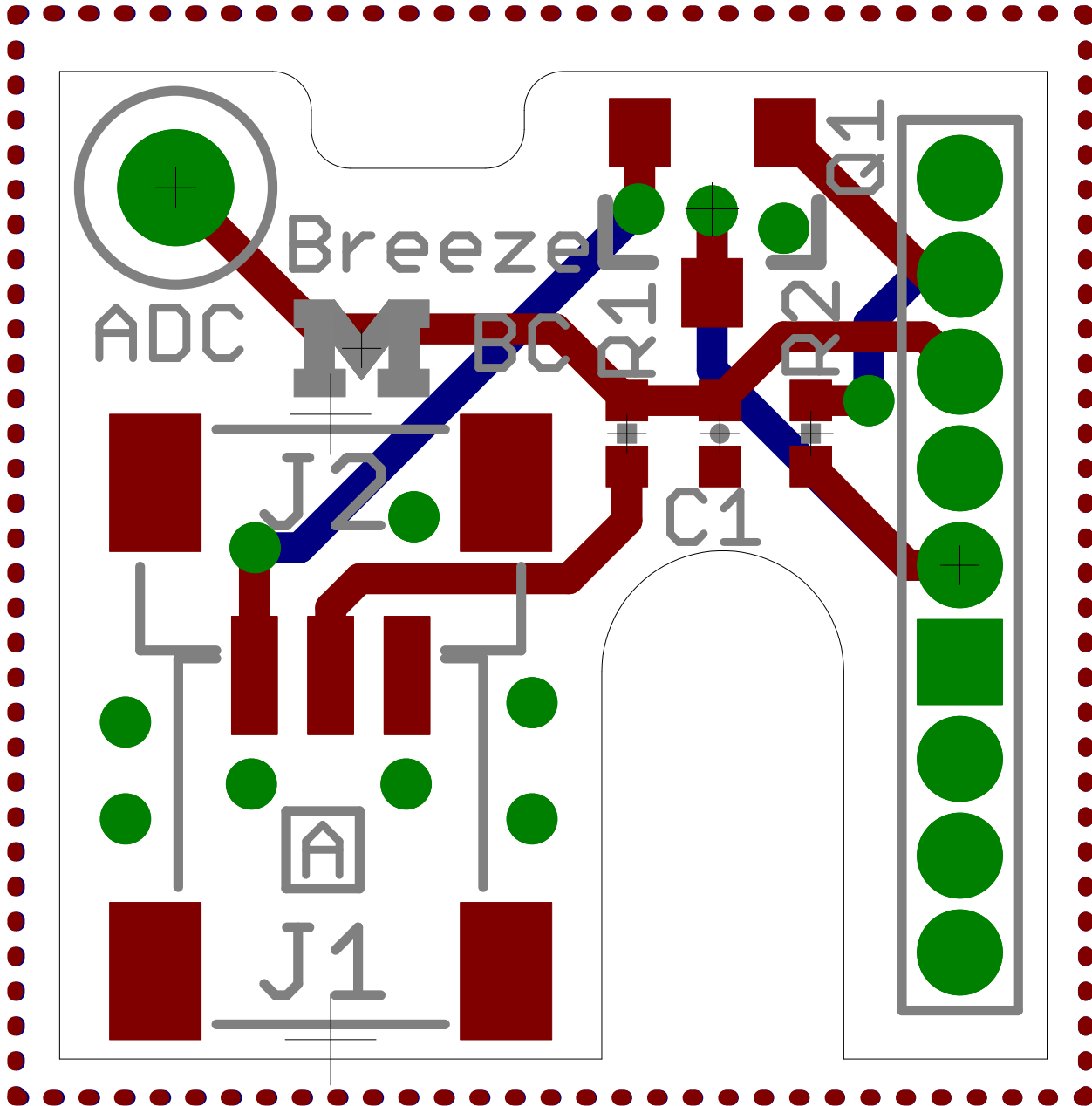

2014/04/28

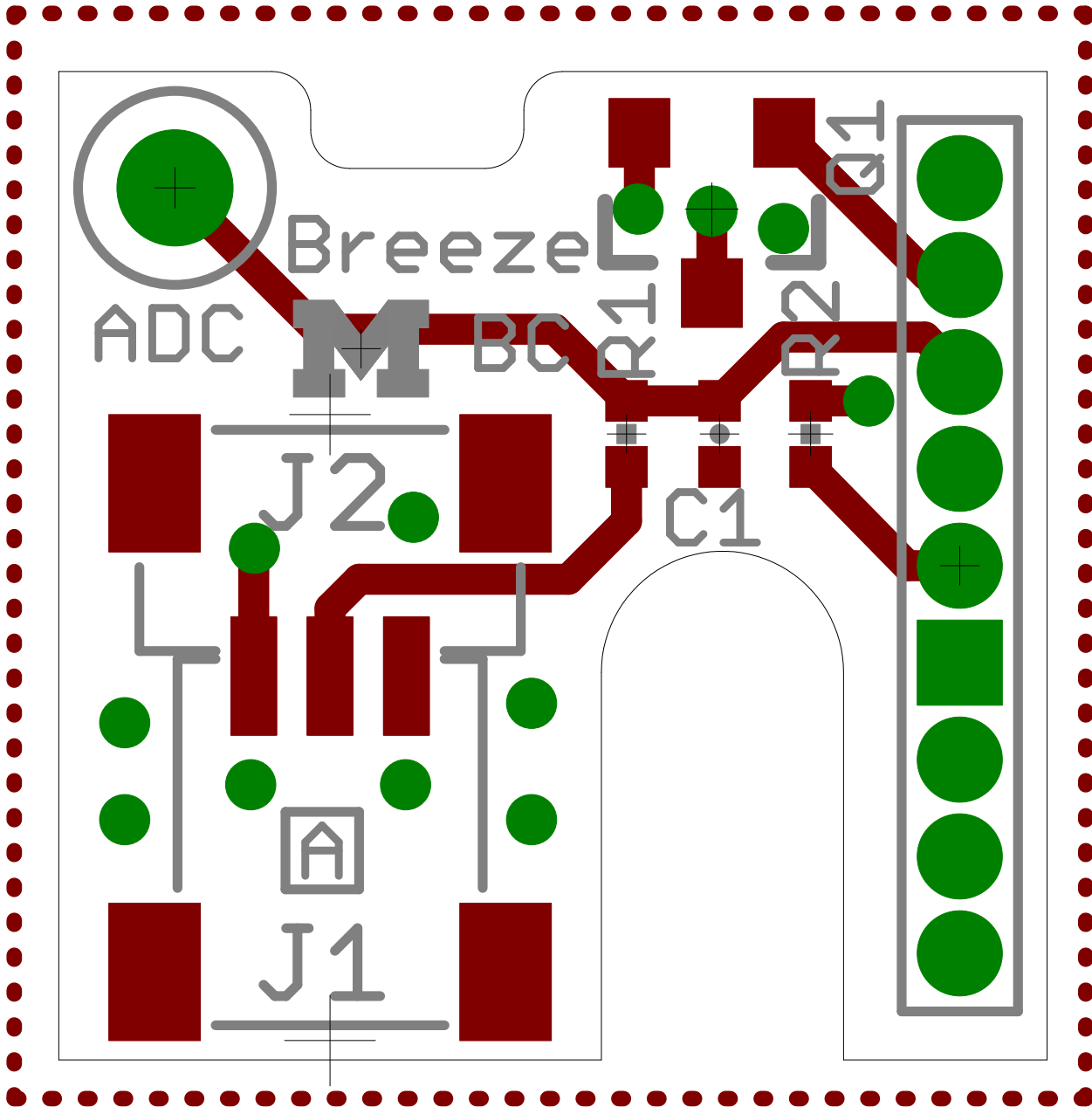

Bottom Layer

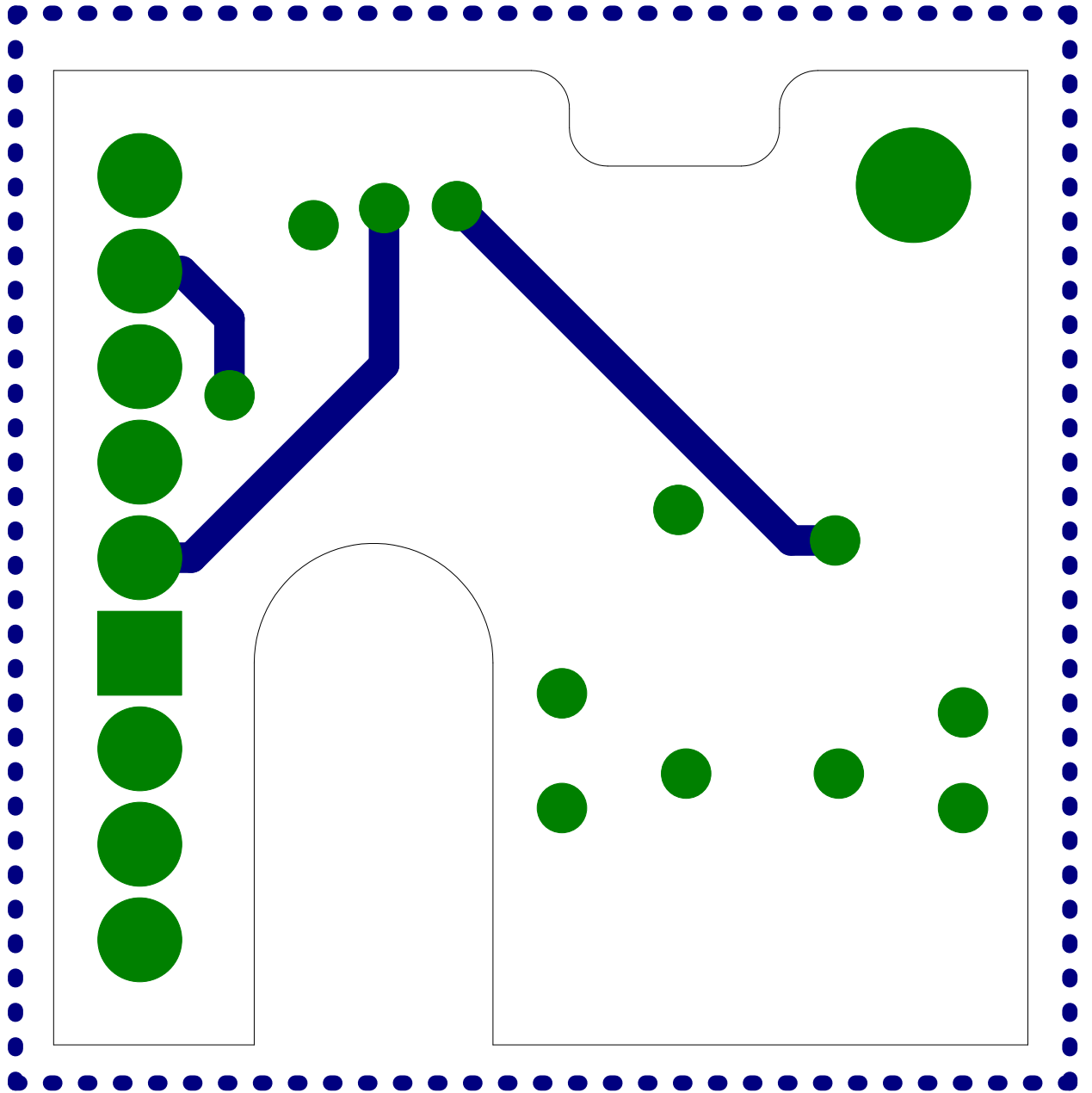

Top Copper Layer

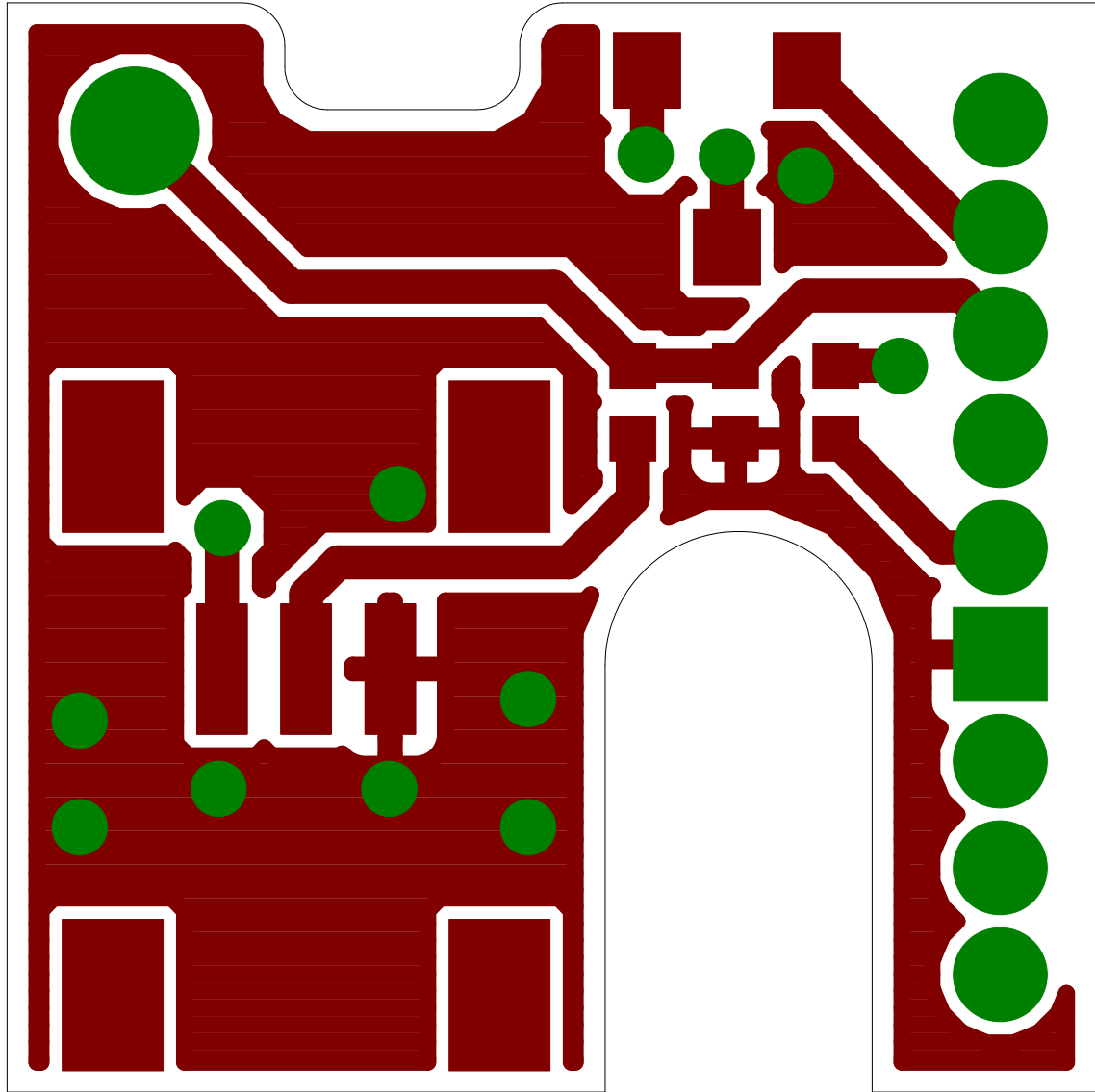

Bottom Copper Layer

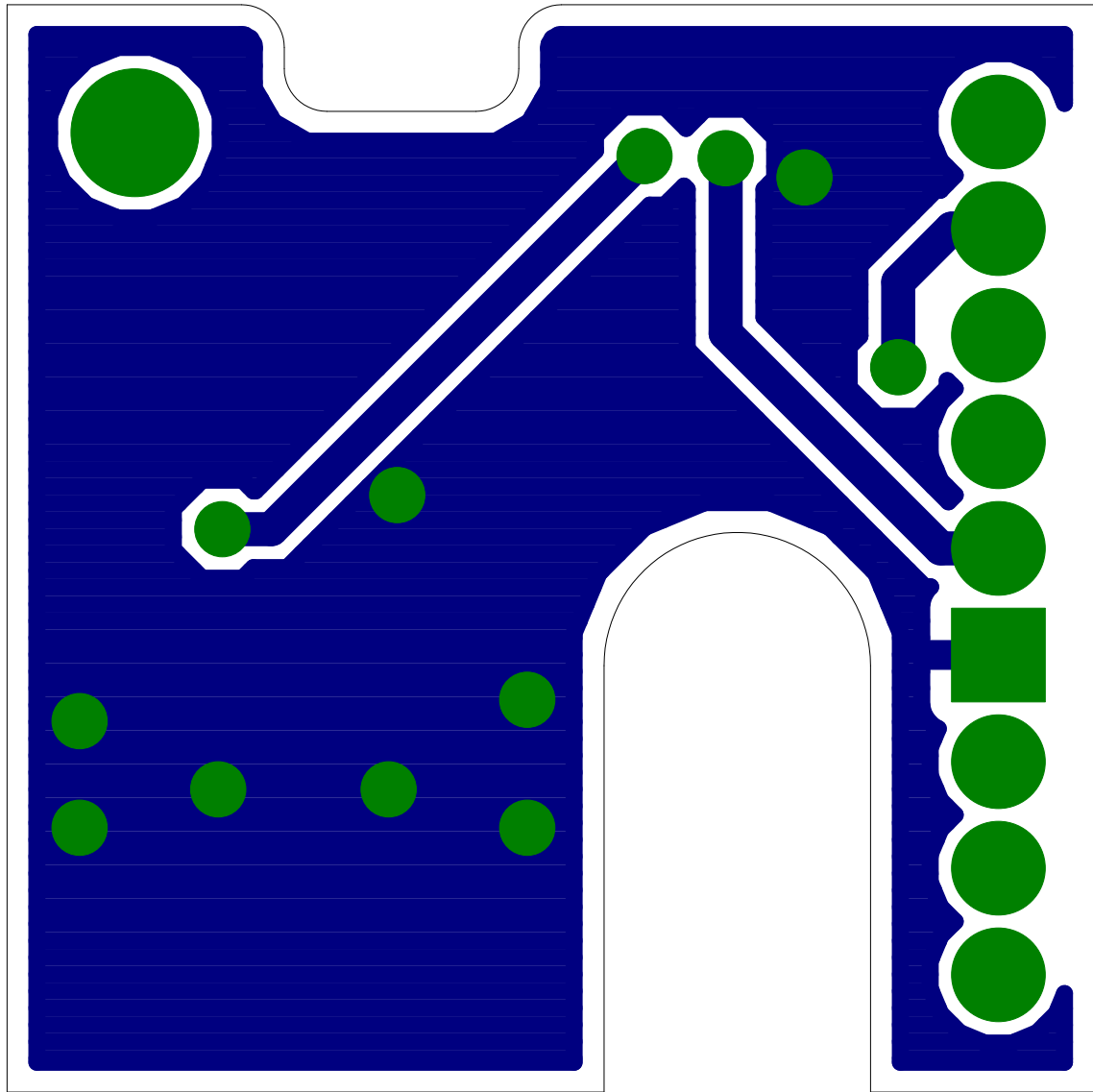

2014/04/28

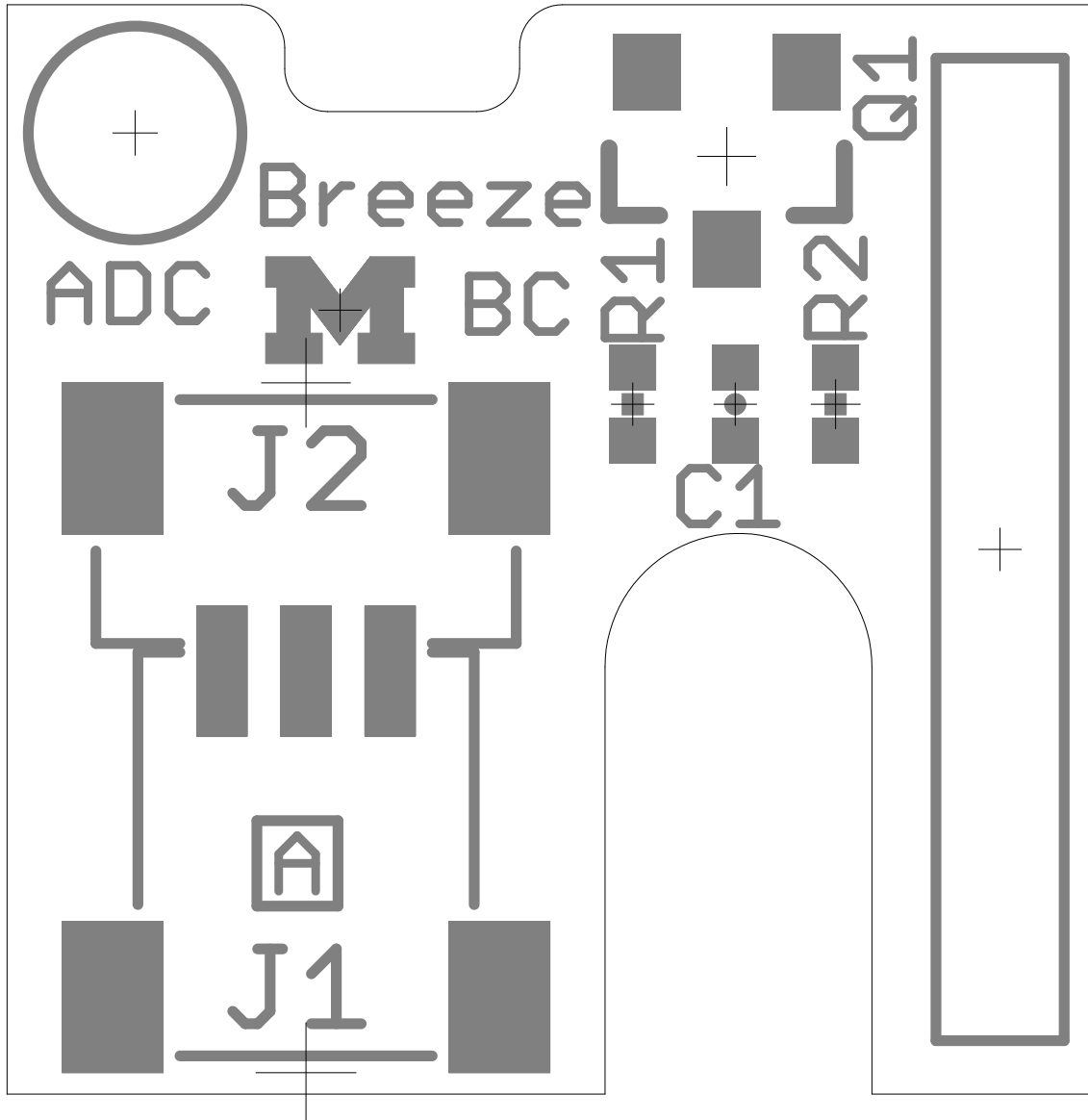

Bottom Paste Layer with Silkscreen

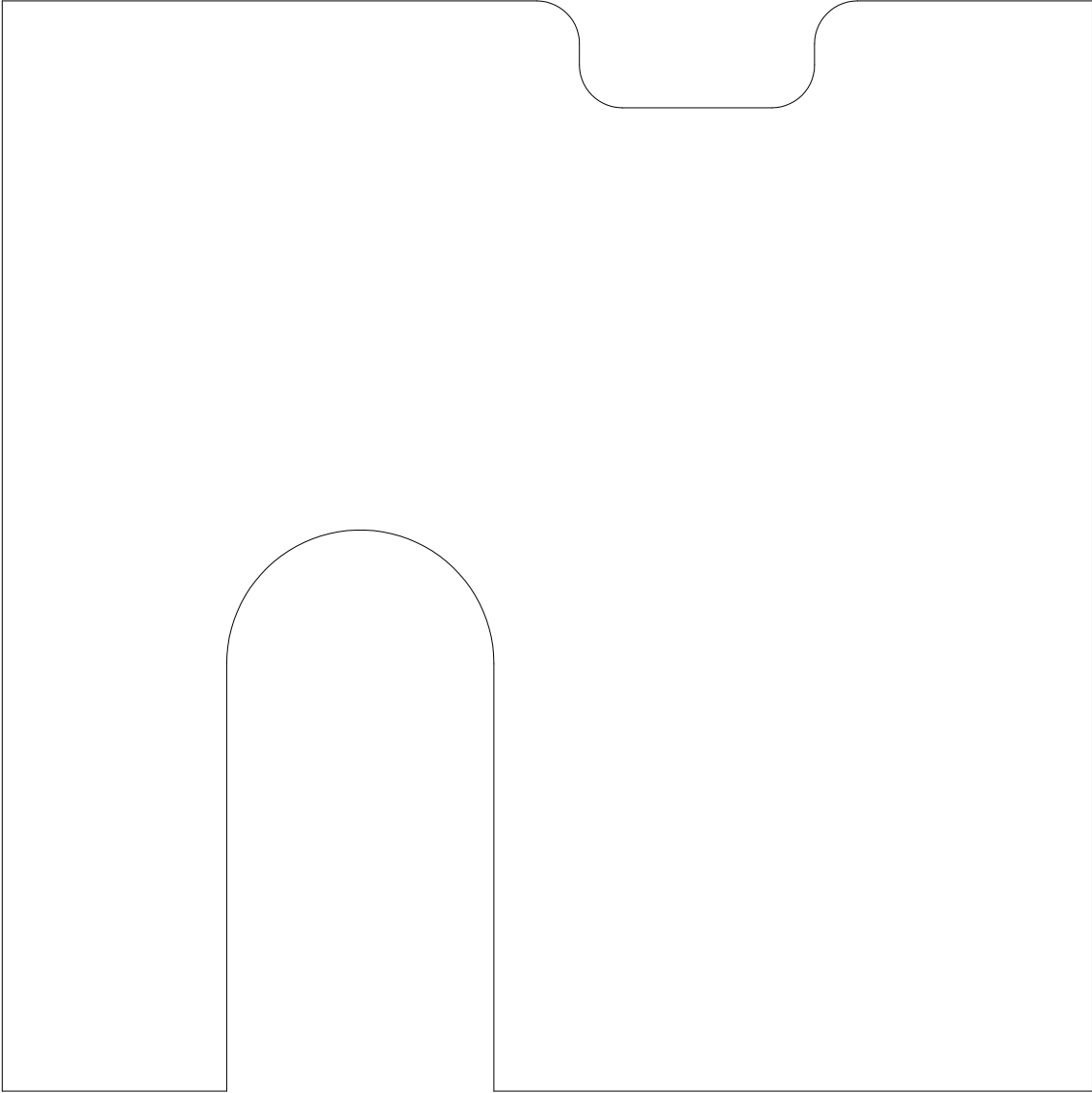

Top and Bottom Layers 1:1 Scale

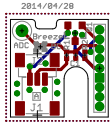

Top Layer 1:1 Scale

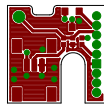

Bottom Copper Layer 1:1 Scale

