

Top and Bottom Layers

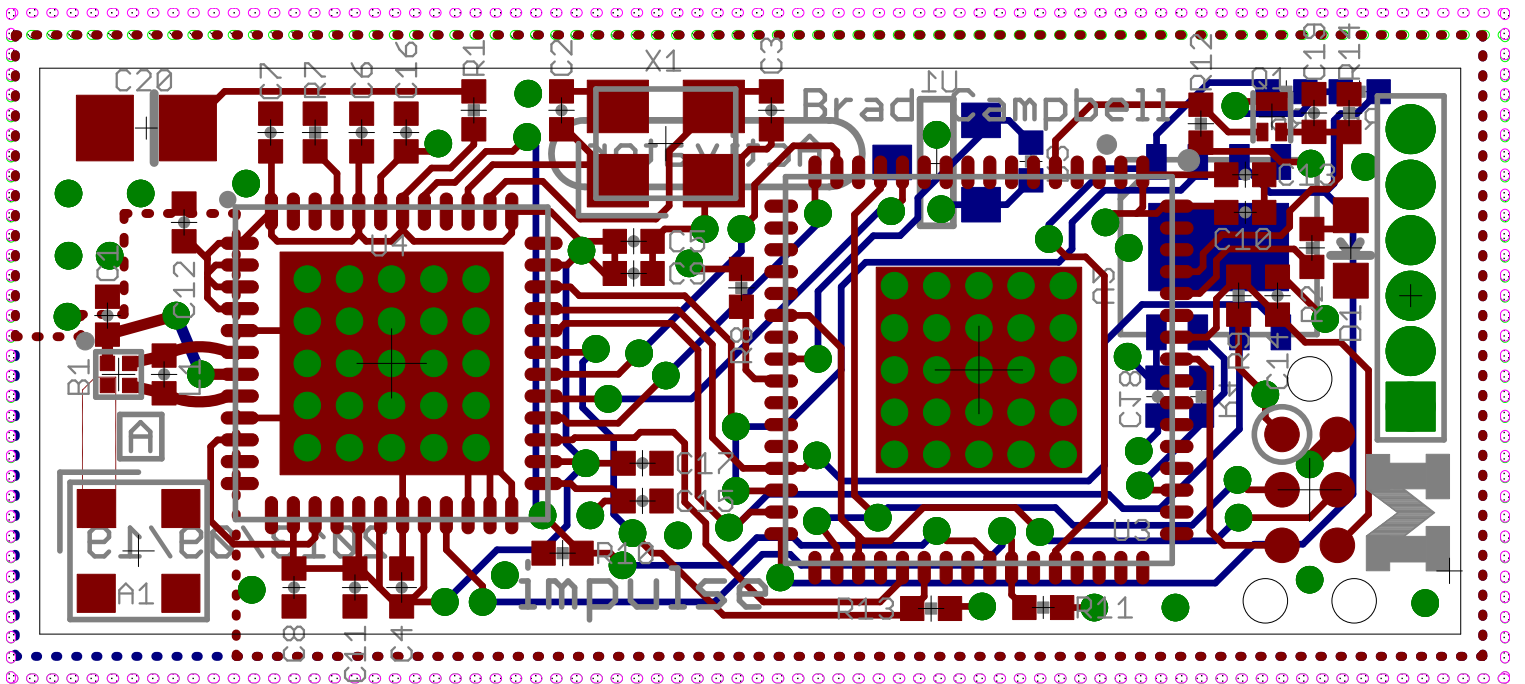

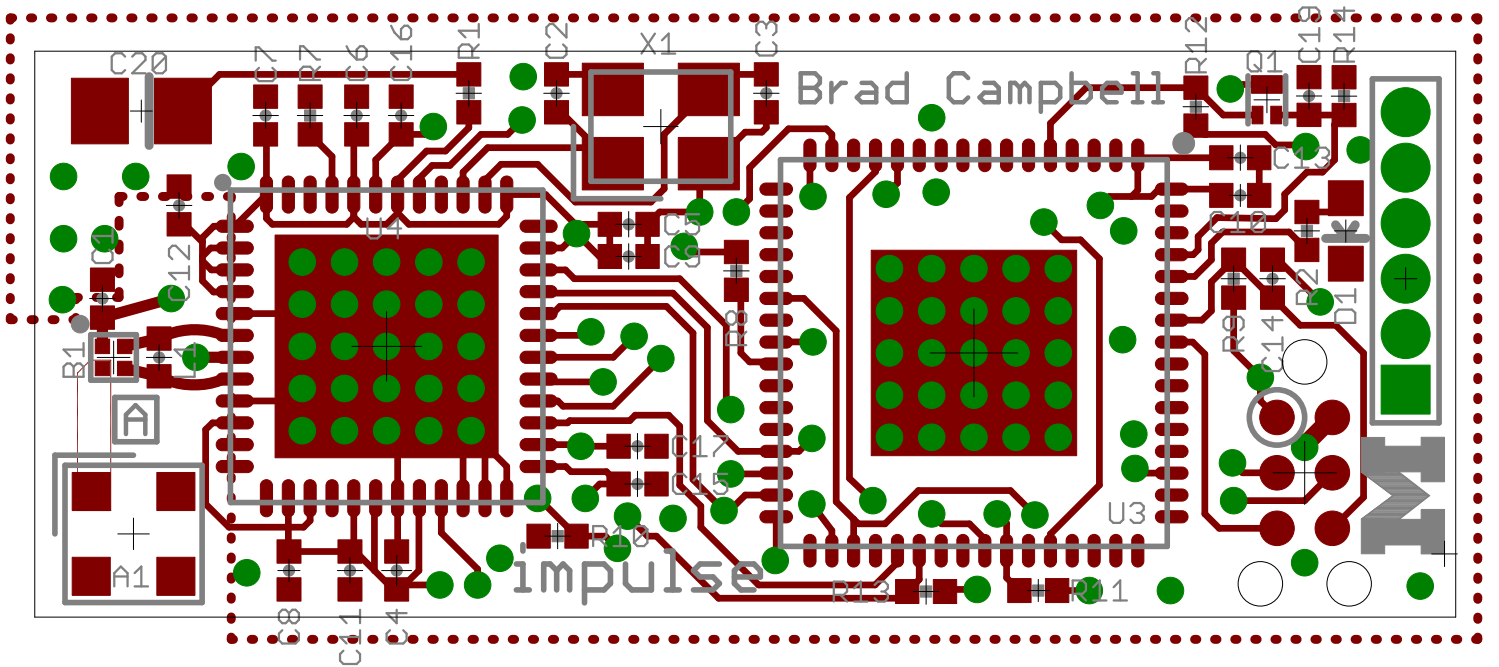

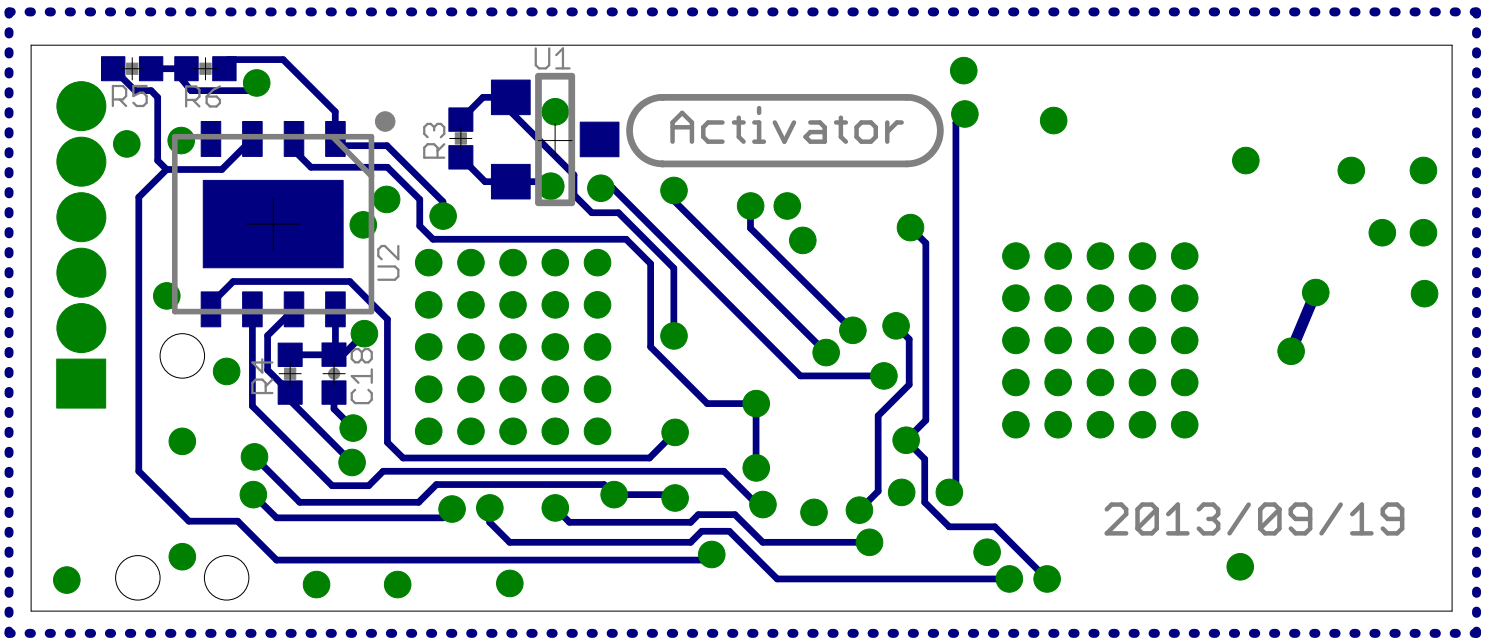

Top Copper Layer

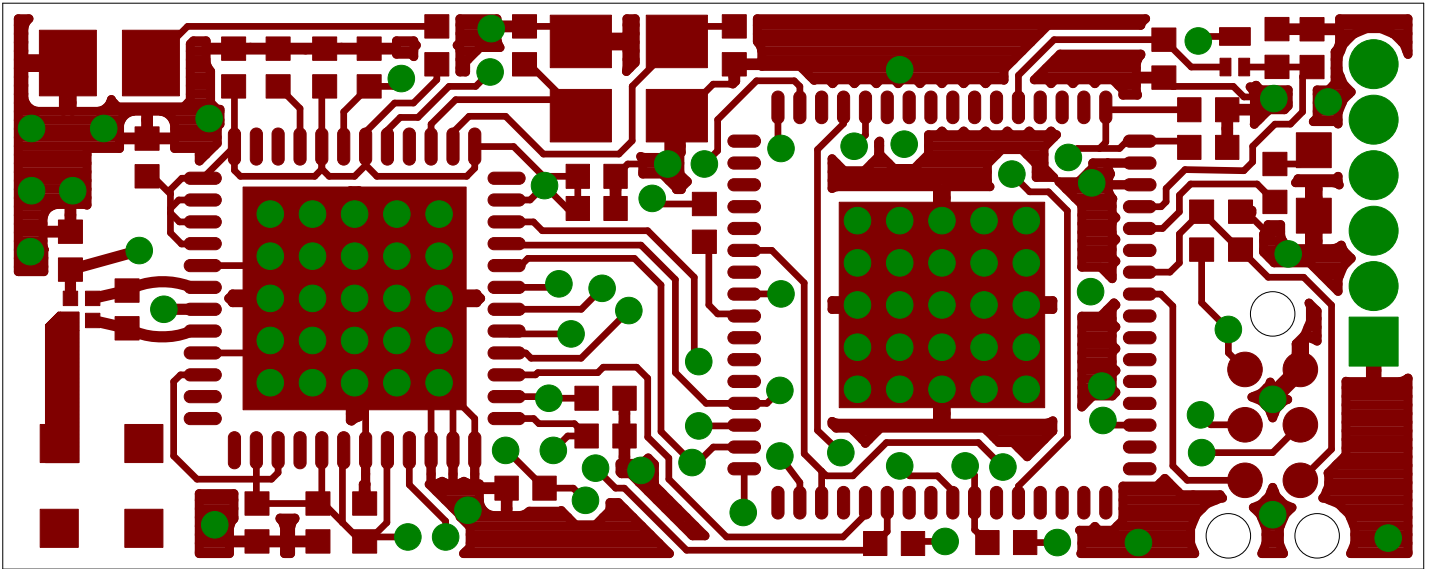

Layer 2 Copper

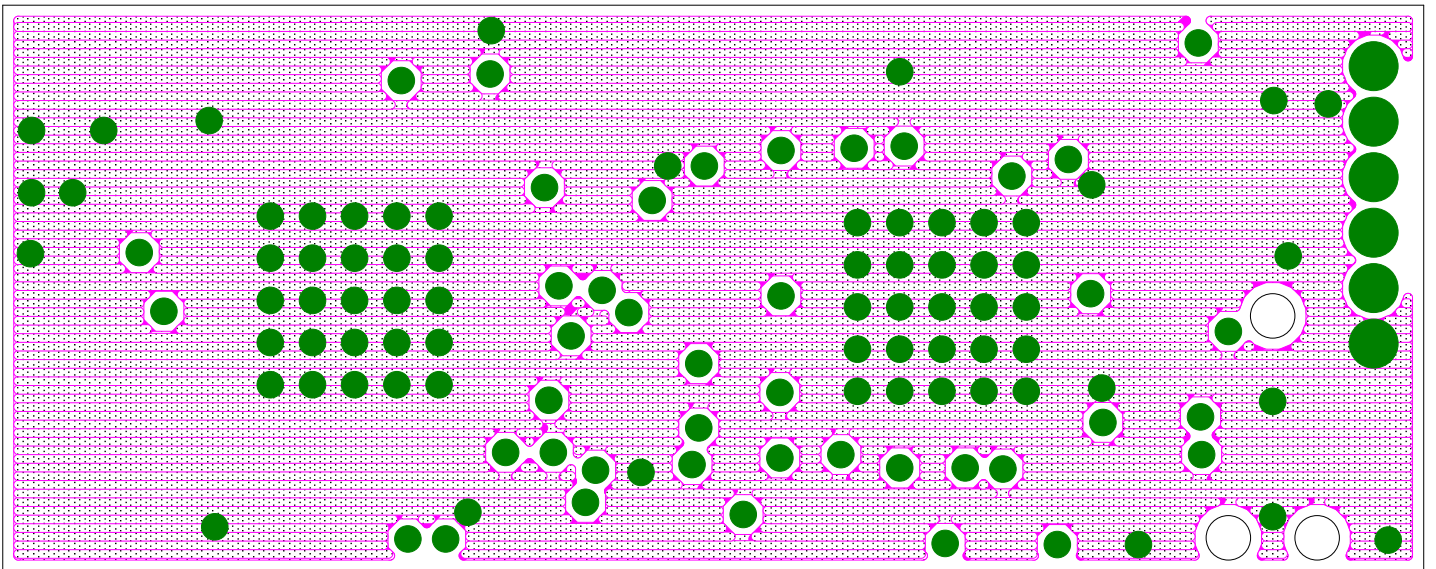

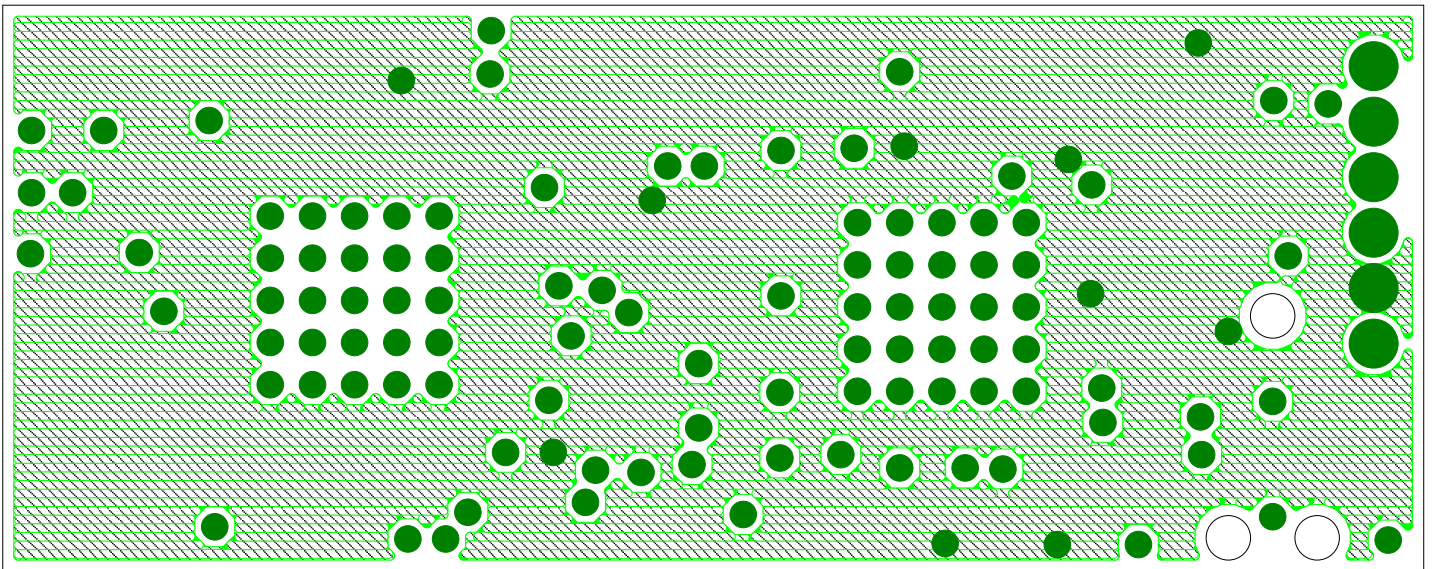



Bottom Copper Layer

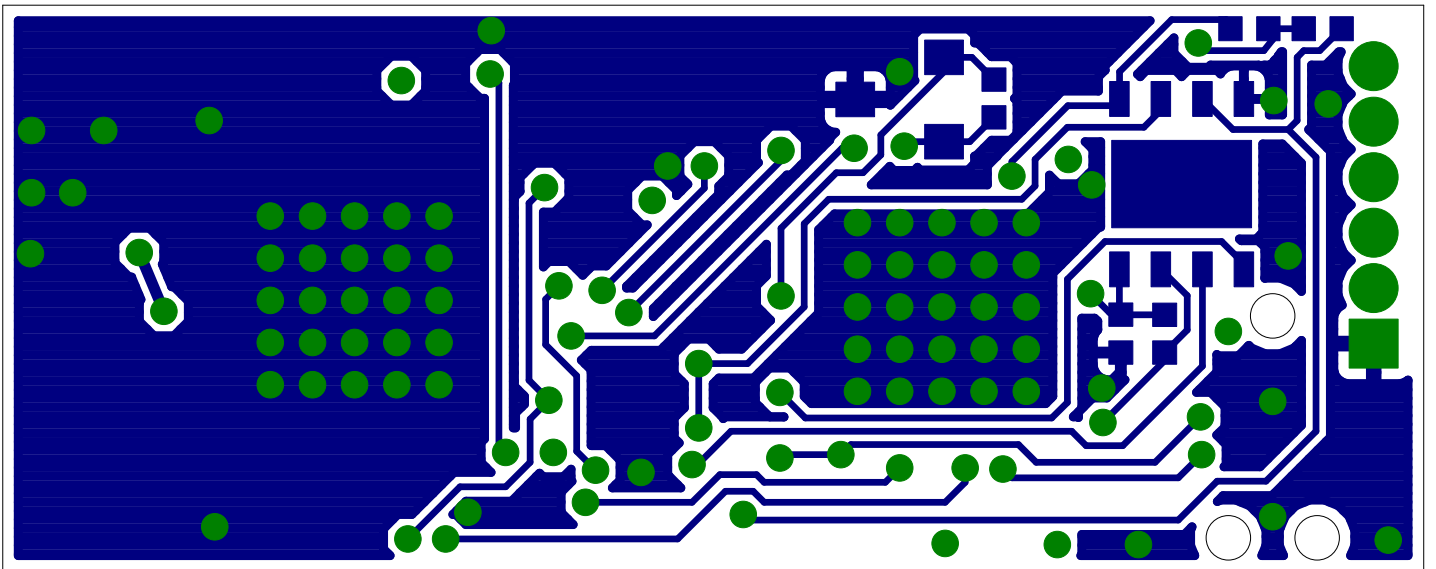

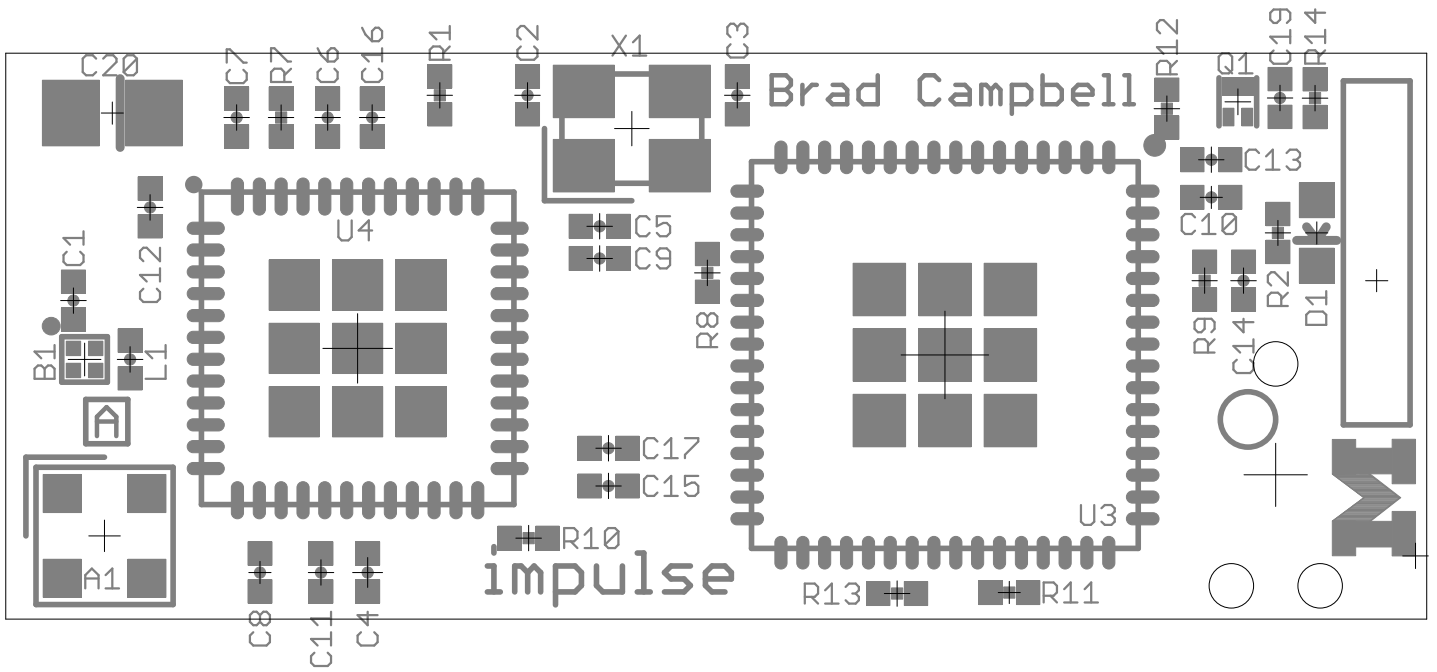

Bottom Paste Layer with Silkscreen

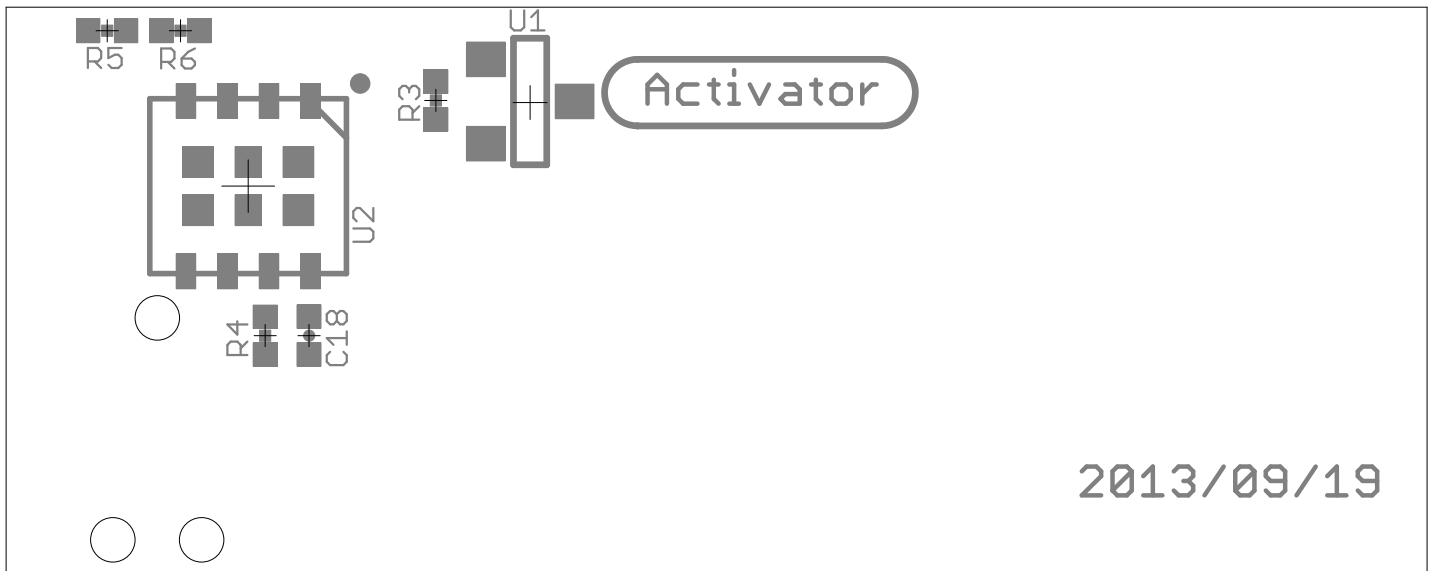

Top and Bottom Layers 1:1 Scale

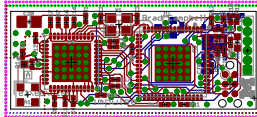

Top Layer 1:1 Scale

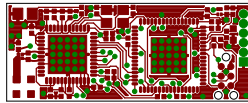

Layer 2 Copper 1:1 Scale

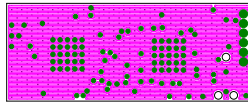

Layer 3 Copper 1:1 Scale

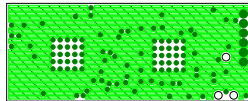

Bottom Copper Layer 1:1 Scale

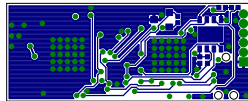



Sheet1

Qty	Value	Device	Package	Parts	Description	DIGIKEY	MOUSER	TAG-CONNECT
1	MOLEX-2.4GHZ-047948	MOLEX-2.4GHZ-047948	MOLEX-47948-ANTENNA	A1		WM4893CT-ND		
1	BD2425N50200A	BD2425N50200A	BD2425N50200A	B1		1173-1063-1-ND		
1	12pF	CAPACITOR	0402_CAP	C1	0402 Capacitor	712-1257-1-ND		
2	22pF	CAPACITOR	0402_CAP	C2, C3	0402 Capacitor	445-1239-1-ND		
4	68pF	CAPACITOR	0402_CAP	C4, C5, C6, C7	0402 Capacitor	445-1245-1-ND		
1	0.01uF	CAPACITOR	0402_CAP	C8	0402 Capacitor	445-1260-1-ND		
10	0.1uF	CAPACITOR	0402_CAP	C9, C10, C11, C12, C13, C14, C15, C16, C17, C	0402 Capacitor	445-1265-1-ND		
1	2.2uF	CAPACITOR	0402_CAP	C19	0402 Capacitor	445-3882-1-ND		
1	10uF	C-USC0805	C0805	C20	CAPACITOR, Americar	478-2561-1-ND		
1		LED-0603	LED-0603	D1	LED			
1	GECKO_POWER_SUPPLY_CONI	GECKO_POWER_SUPPLY_CONI	HEADER1X6/0.05IN	J1	Header on the gecko power supply board.			
1	EPIC-PROG-POGO-NO-LEGS	EPIC-PROG-POGO-NO-LEGS	TC2030-IDC-NL	J2	Epic programmer based on the Tag Connect pogo pin cable.			TC2030-IDC-NL
1	INDUCTOR0402	INDUCTOR0402	0402_CAP	L1		712-1419-1-ND		
1	MOSFET-NCHANNELXFDN-3	MOSFET-NCHANNELXFDN-3	XFDN-3	Q1	Generic NMOS footprin	DMN2400UFB4-7DICT-ND		
1	2.2	RESISTOR	0402_RES	R1	Resistor	RHM2.2CECT-ND		
1	470	RESISTOR	0402_RES	R2	Resistor			
1	2.2k	RESISTOR	0402_RES	R3	Resistor	RHM2.2KCECT-ND		
1	34.7k	RESISTOR	0402_RES	R4, R5, R6	Resistor	RHM4.7KCECT-ND		
1	43k	RESISTOR	0402_RES	R7	Resistor	RHM43KCECT-ND		
2	100k	RESISTOR	0402_RES	R8, R9	Resistor	RHM100KCECT-ND		
4	1M	RESISTOR	0402_RES	R10, R11, R12, R13	Resistor	RHM1.0MCECT-ND		
1	14.7M	RESISTOR	0402_RES	R14	Resistor	541-4.7MJCT-ND		
1	DS2411	DS2411	SOT-23	U1	Maxim DS2411	DS2411R+CT-ND		
1	FM25LBTDFN-8	FM25LBTDFN-8	TDFN-8	U2	IC FRAM 4KBIT 10MHz	FM25L04B-DGRA-ND	877-FM25L04B-DG	
1	MSP430F1611IRTD	MSP430F1611IRTD	S-PVQFN-N64	U3		296-18102-1-ND		
1	CC2420RGZ	CC2420RGZ	S-PVQFN-N48	U4	2.4 GHz IEEE 802.15.4	296-19585-1-ND		
1	TXC-7V	TXC-7V	TXC-7V	X1		887-1799-1-ND		