

TITLE: ecg_sensor	
Document Number:	REV:
Date: 1/9/14 1:54 AM	Sheet: 1/1

Top and Bottom Layers

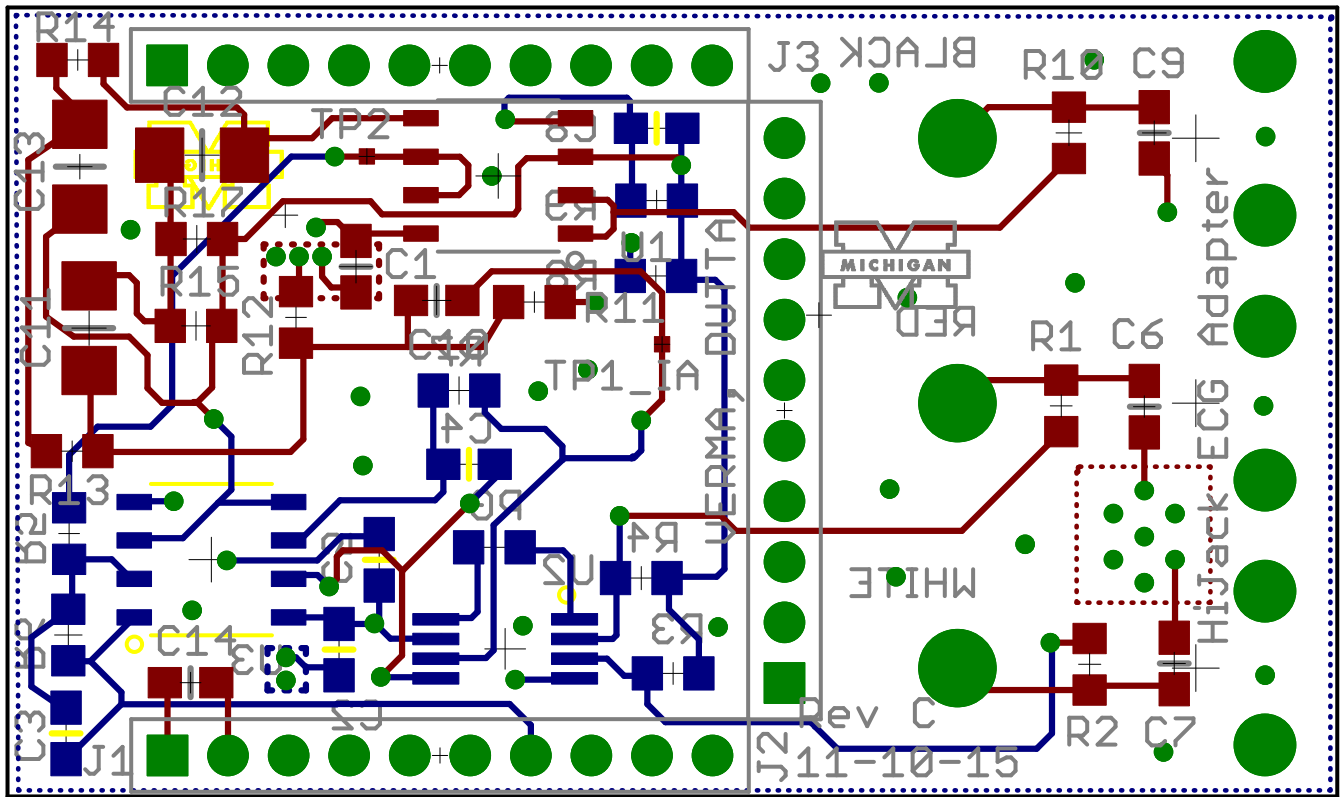

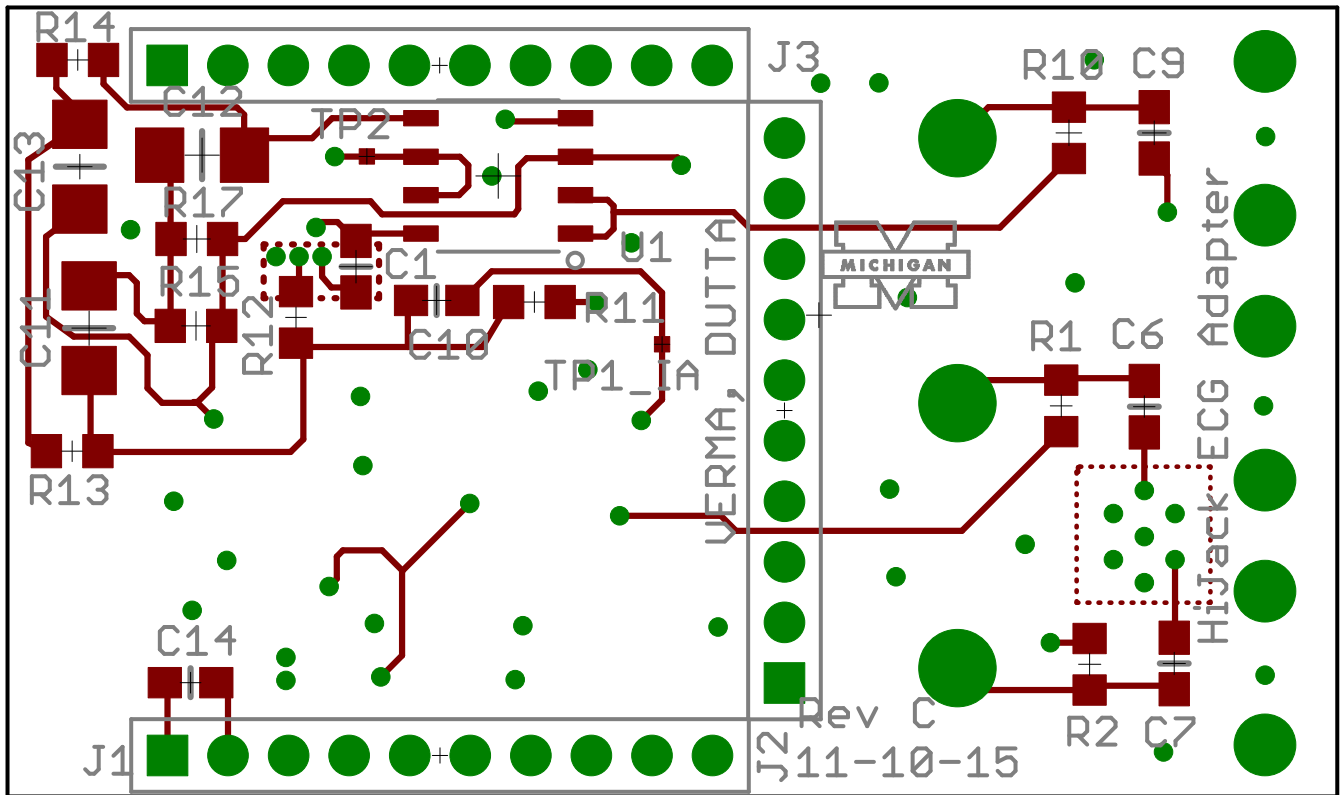

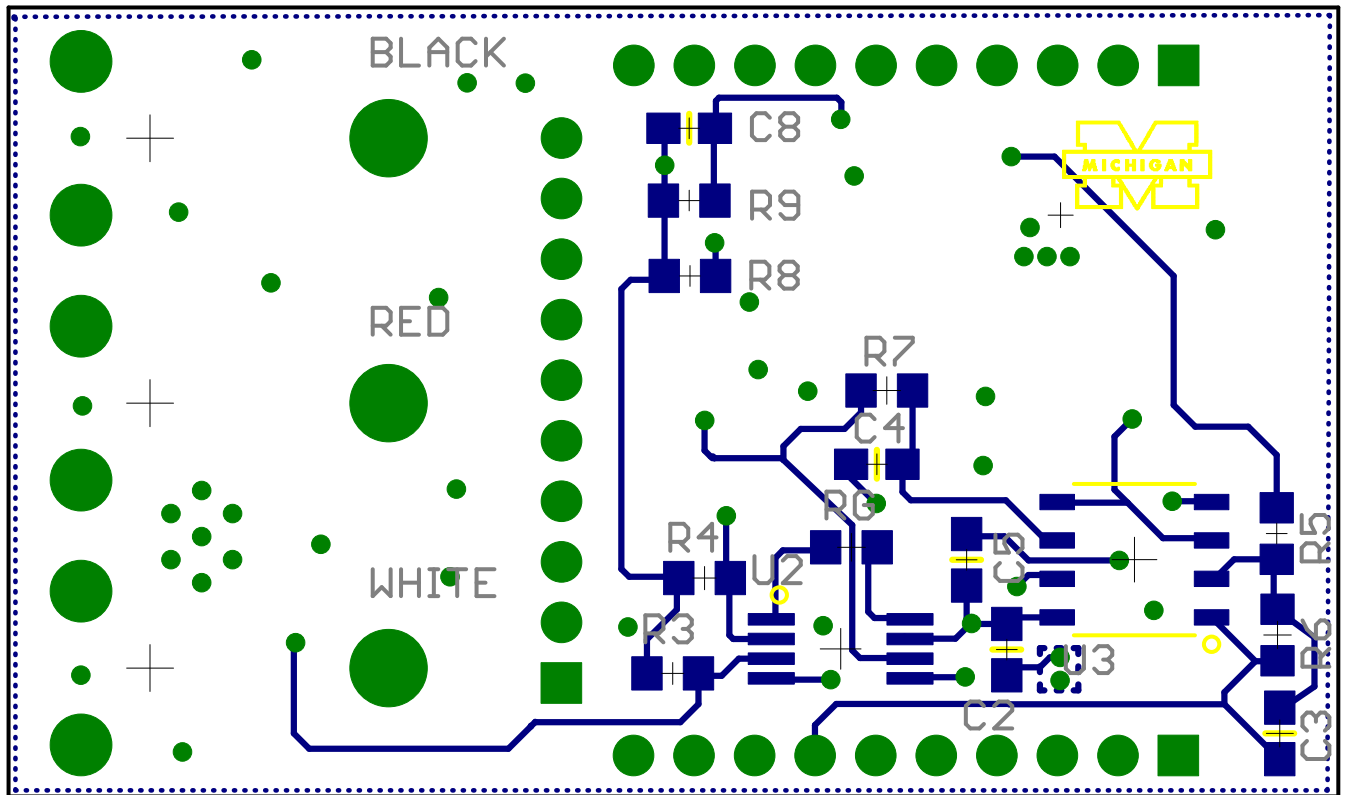

Top Copper Layer

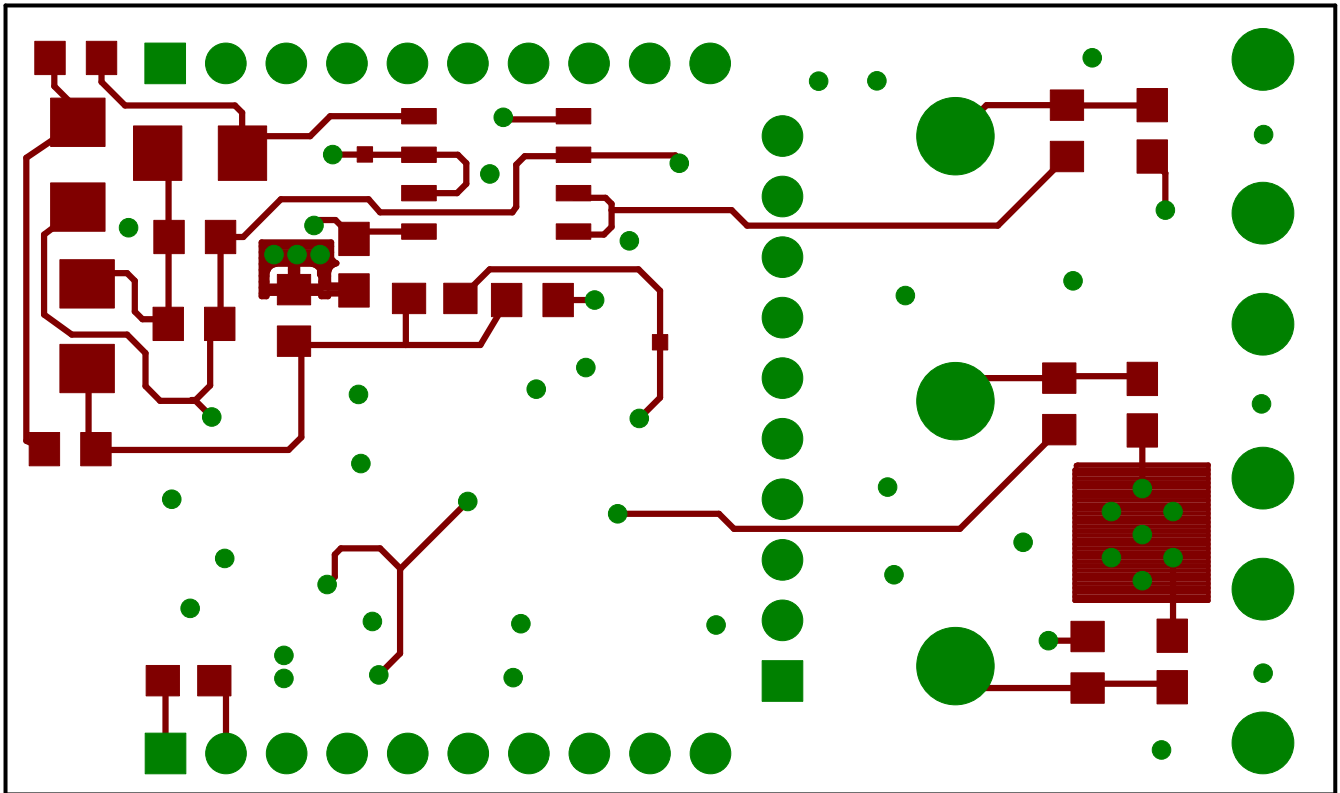

Bottom Copper Layer

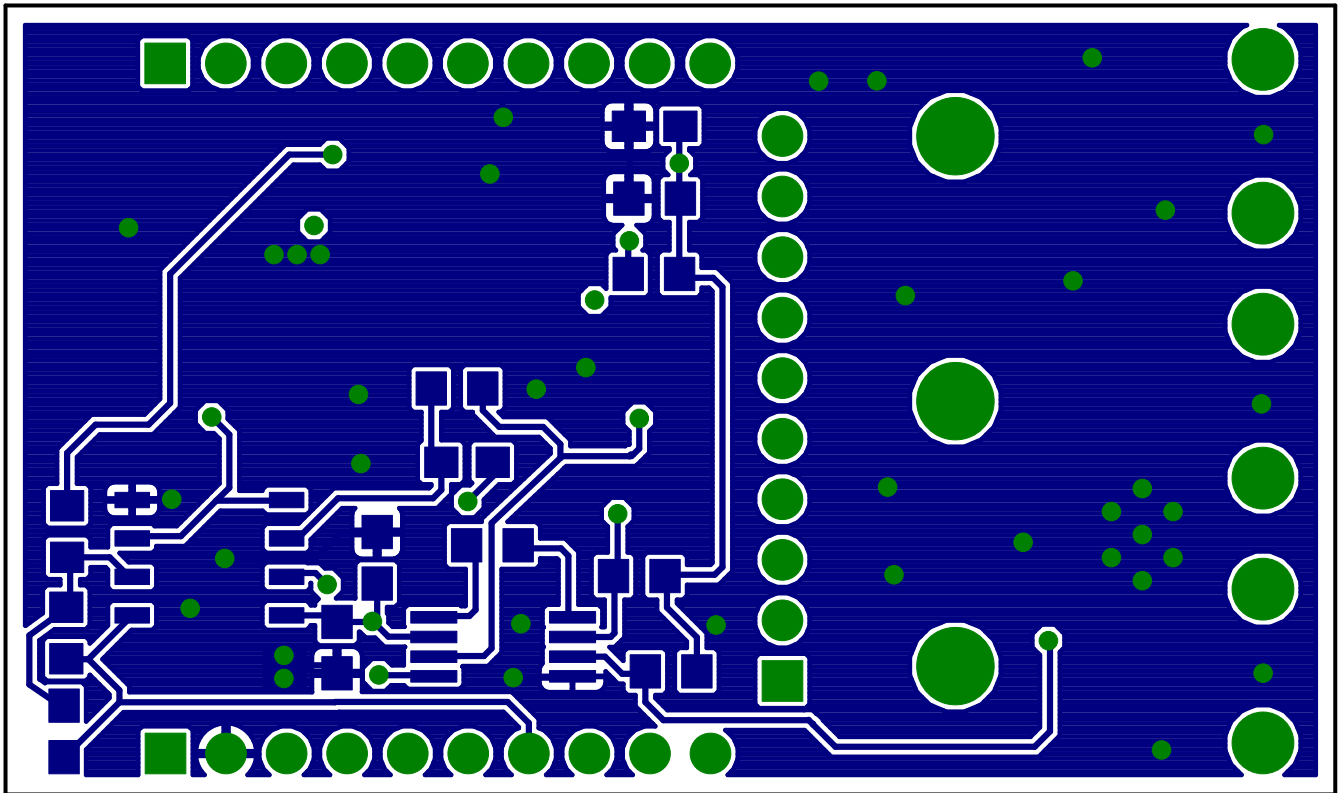

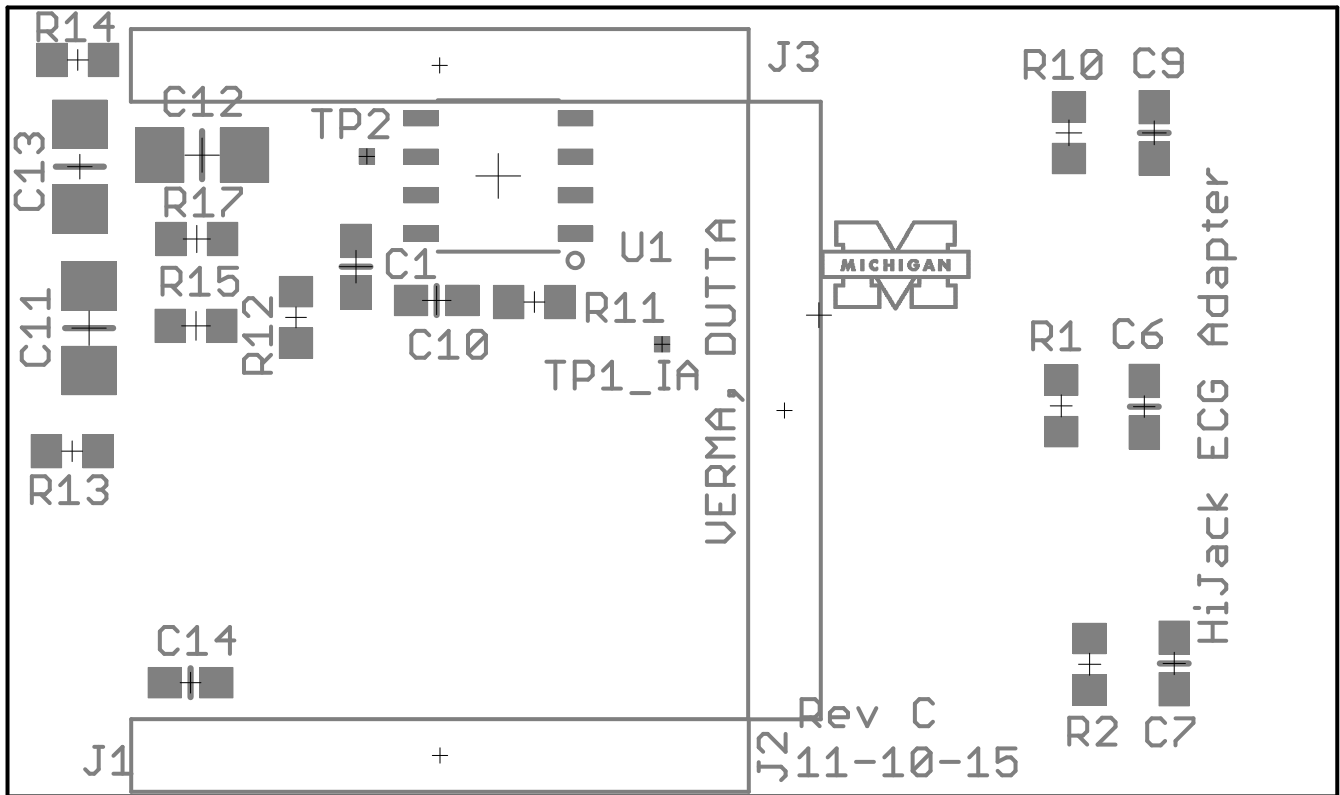

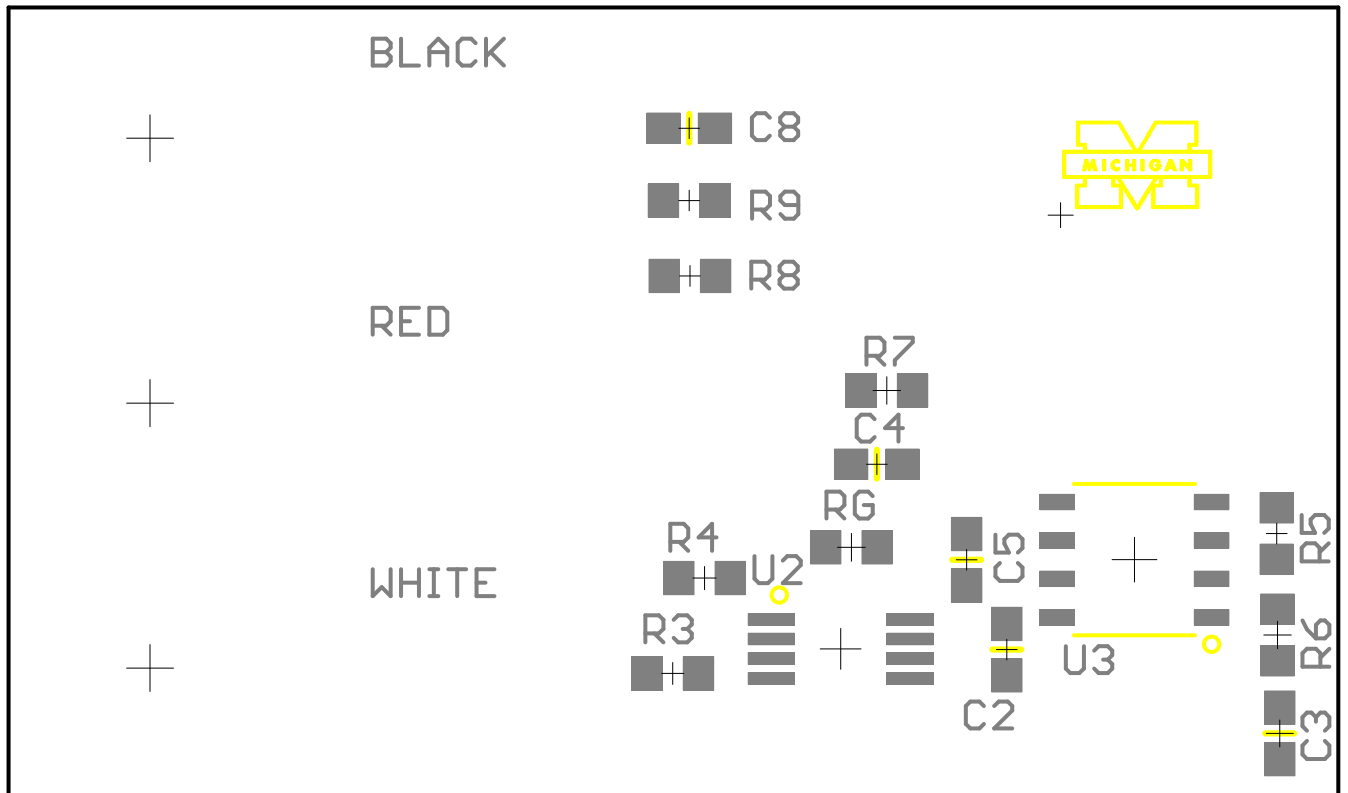

Top and Bottom Layers 1:1 Scale

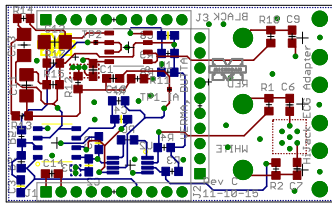

Top Layer 1:1 Scale

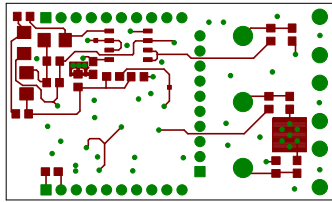

Bottom Copper Layer 1:1 Scale

