

Prabal Dutta / University of Michigan	
TITLE: HIJACK_A	
Document Number:	REV:
Date: 1/9/14 11:47 PM	Sheet: 1/1

Top and Bottom Layers

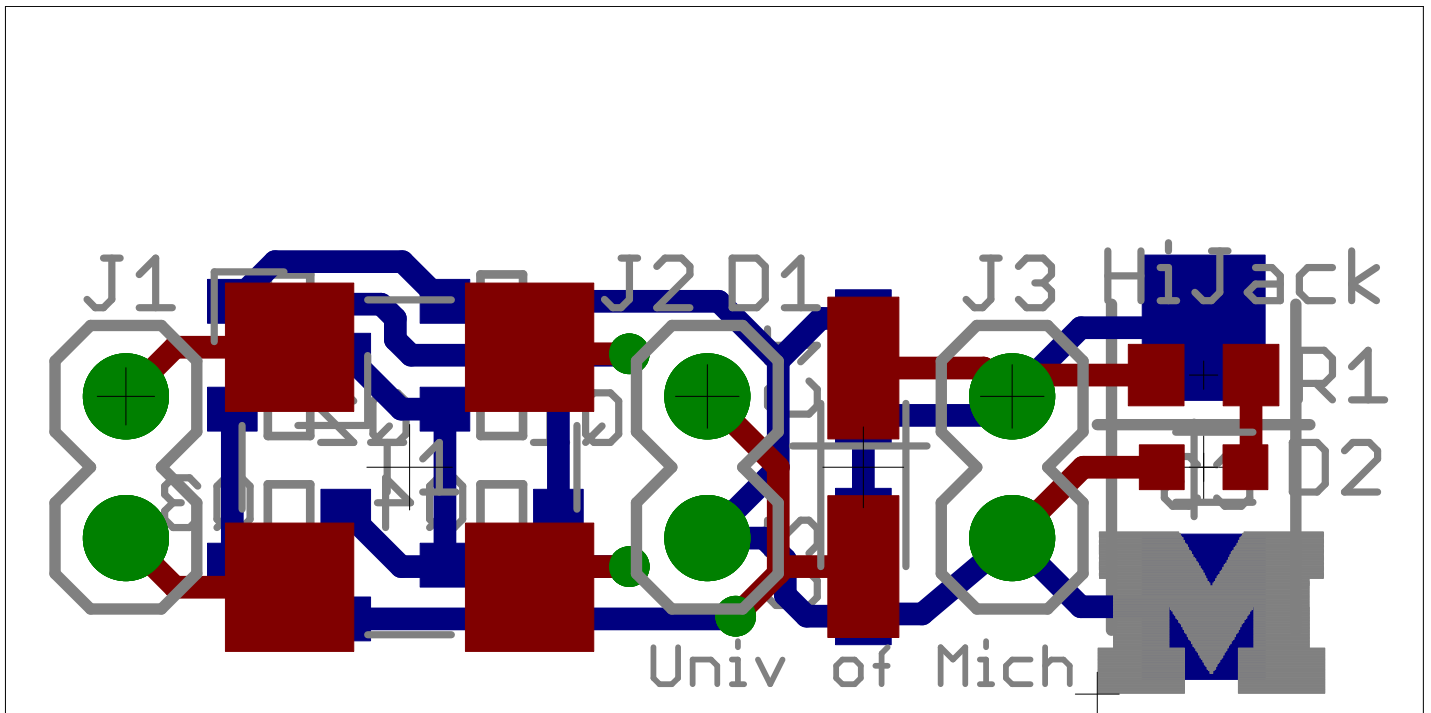

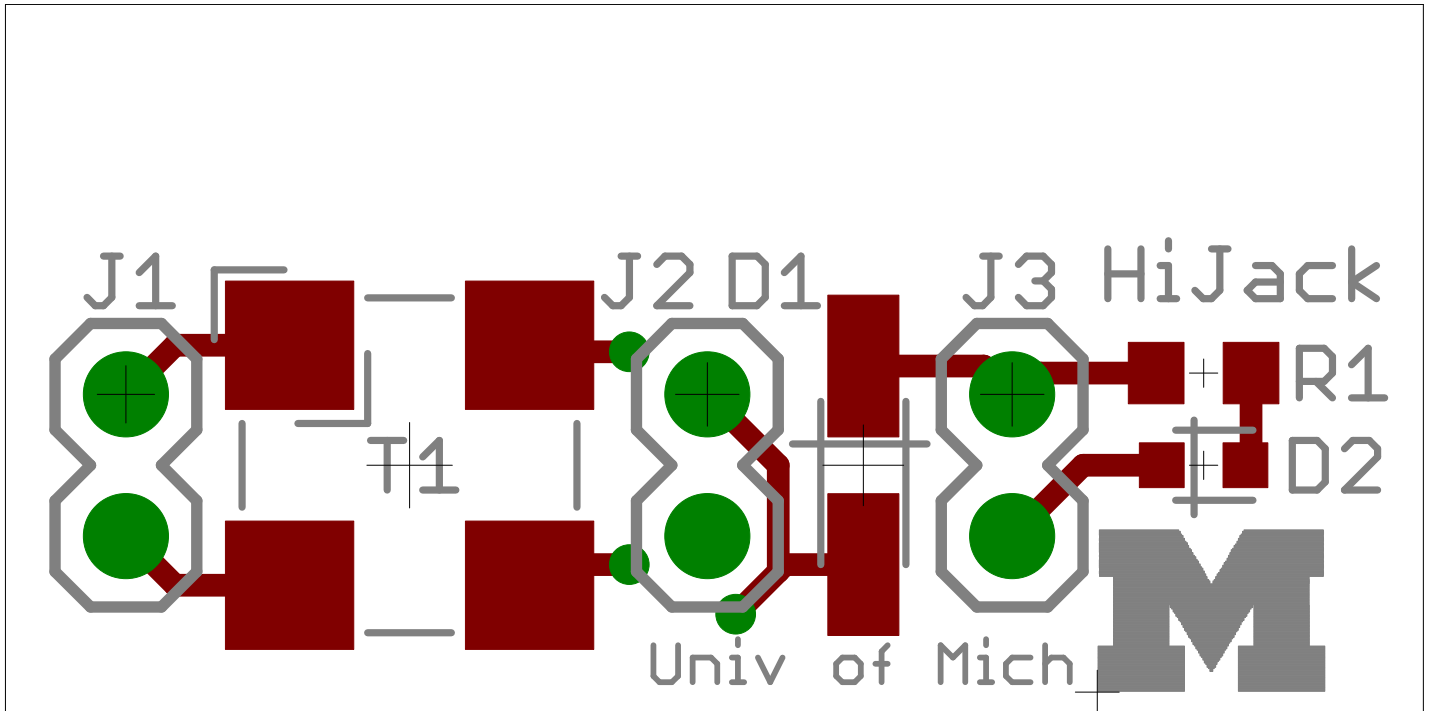

Bottom Layer

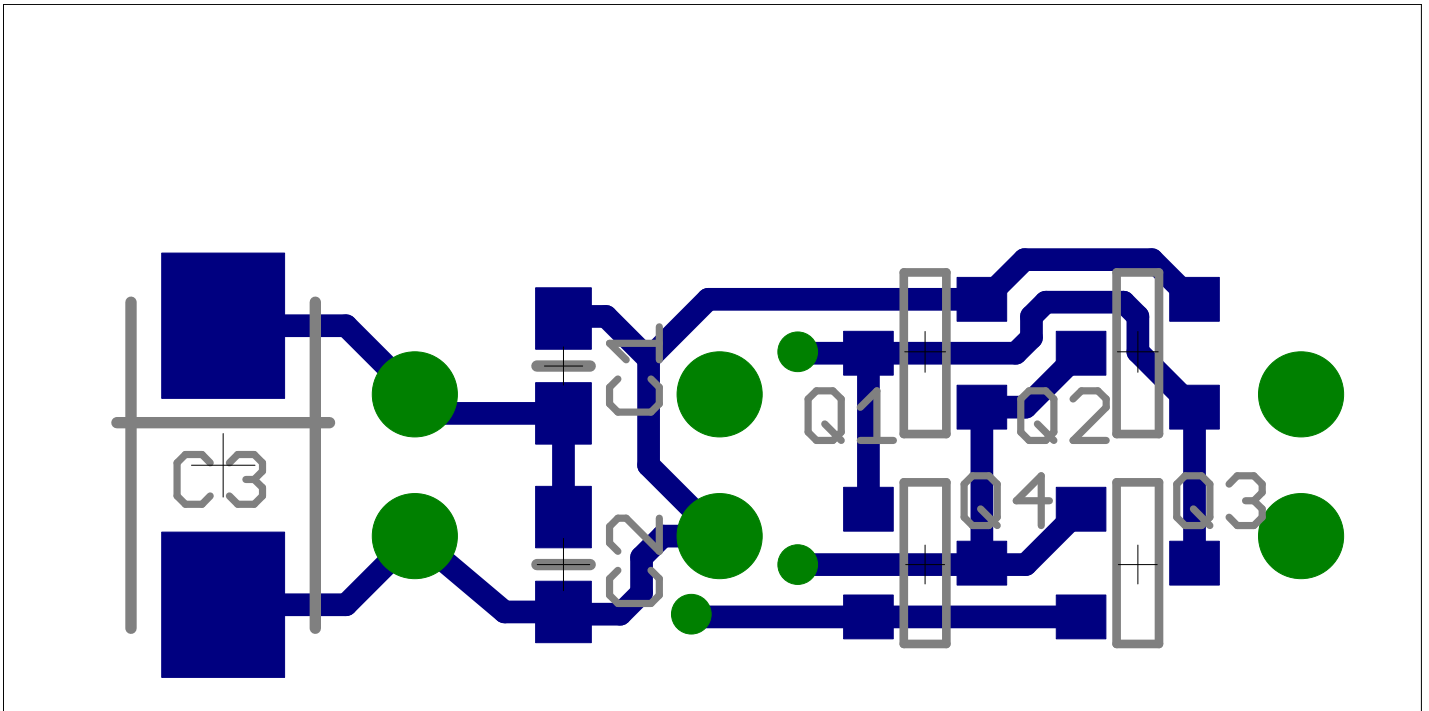

Top Copper Layer

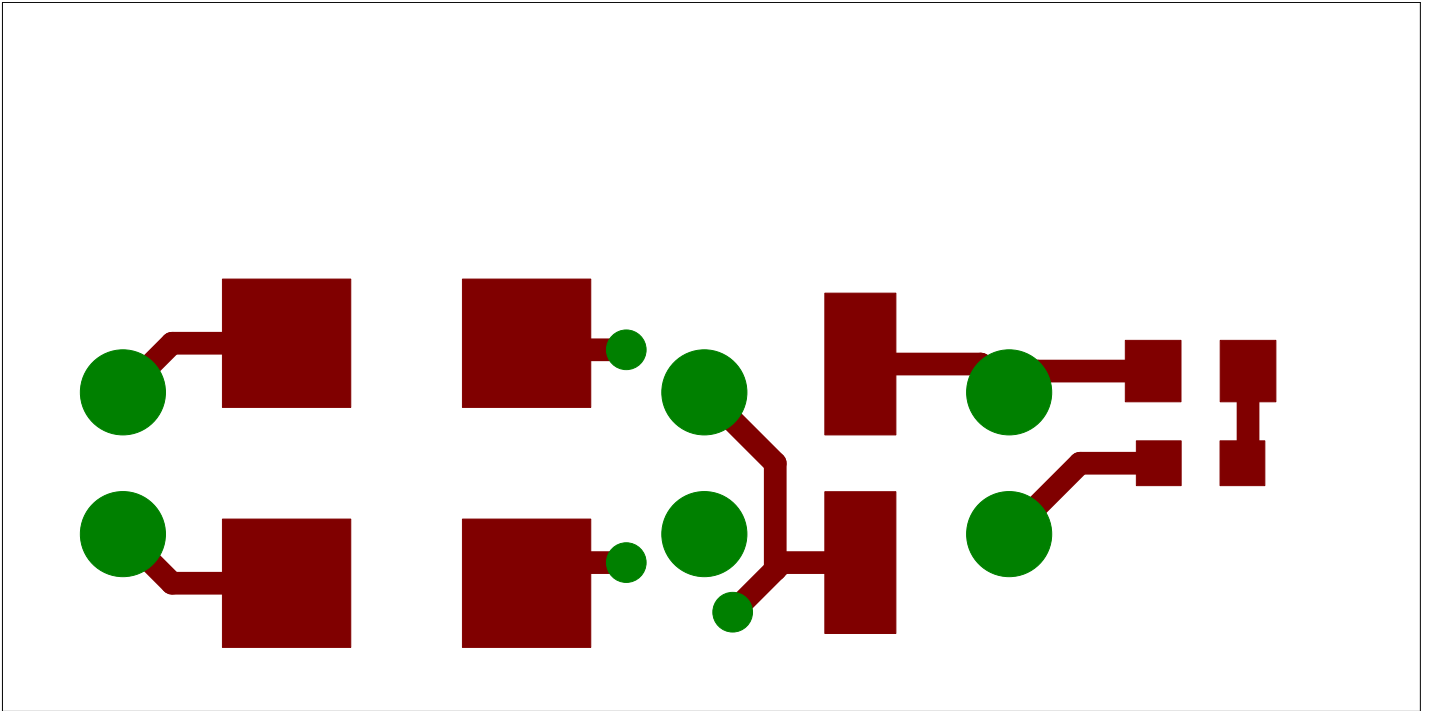

Bottom Copper Layer

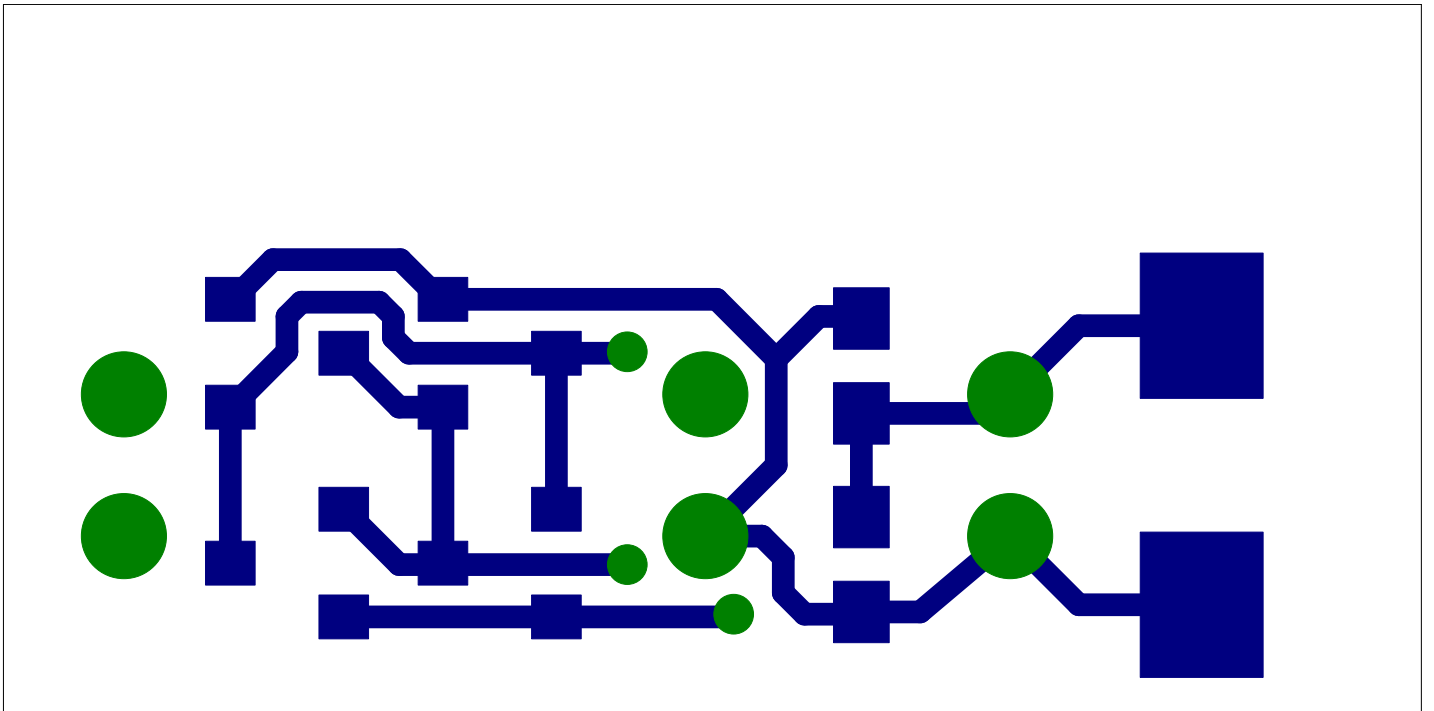

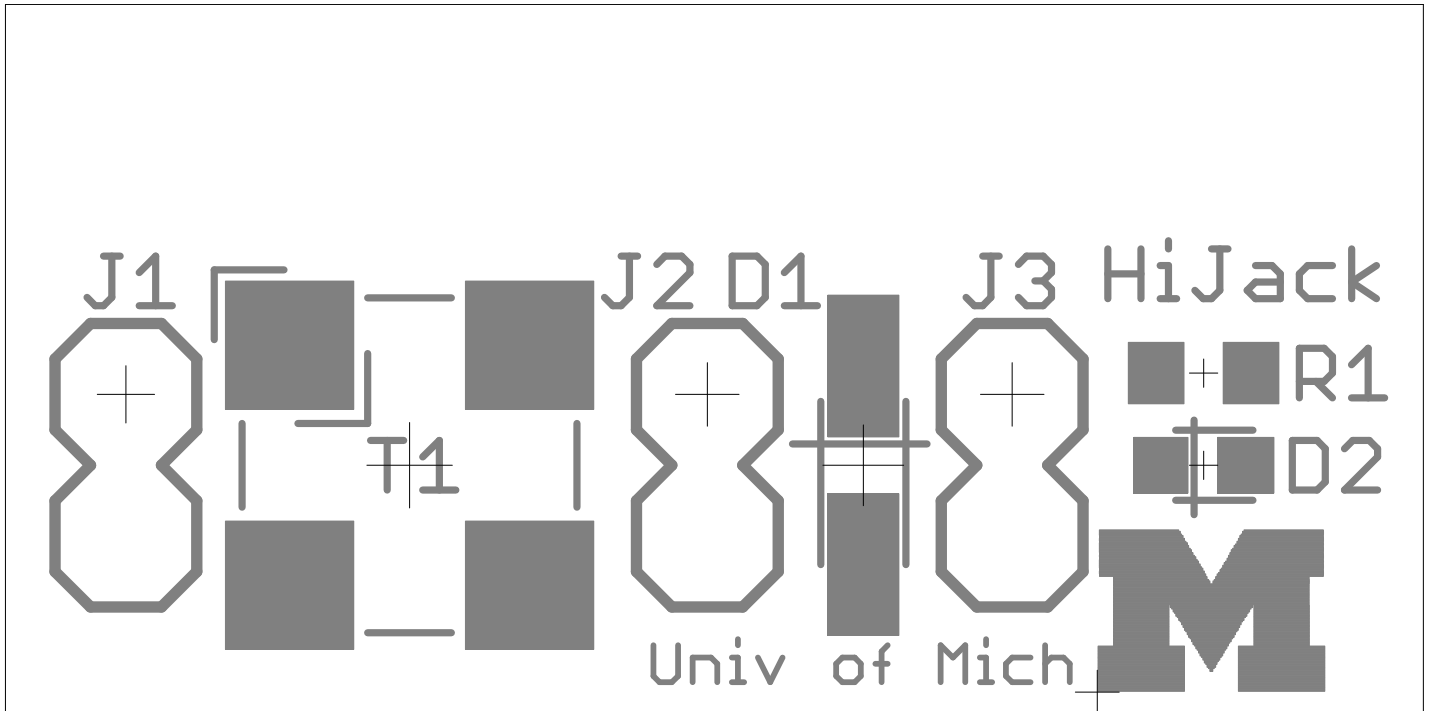

Bottom Paste Layer with Silkscreen

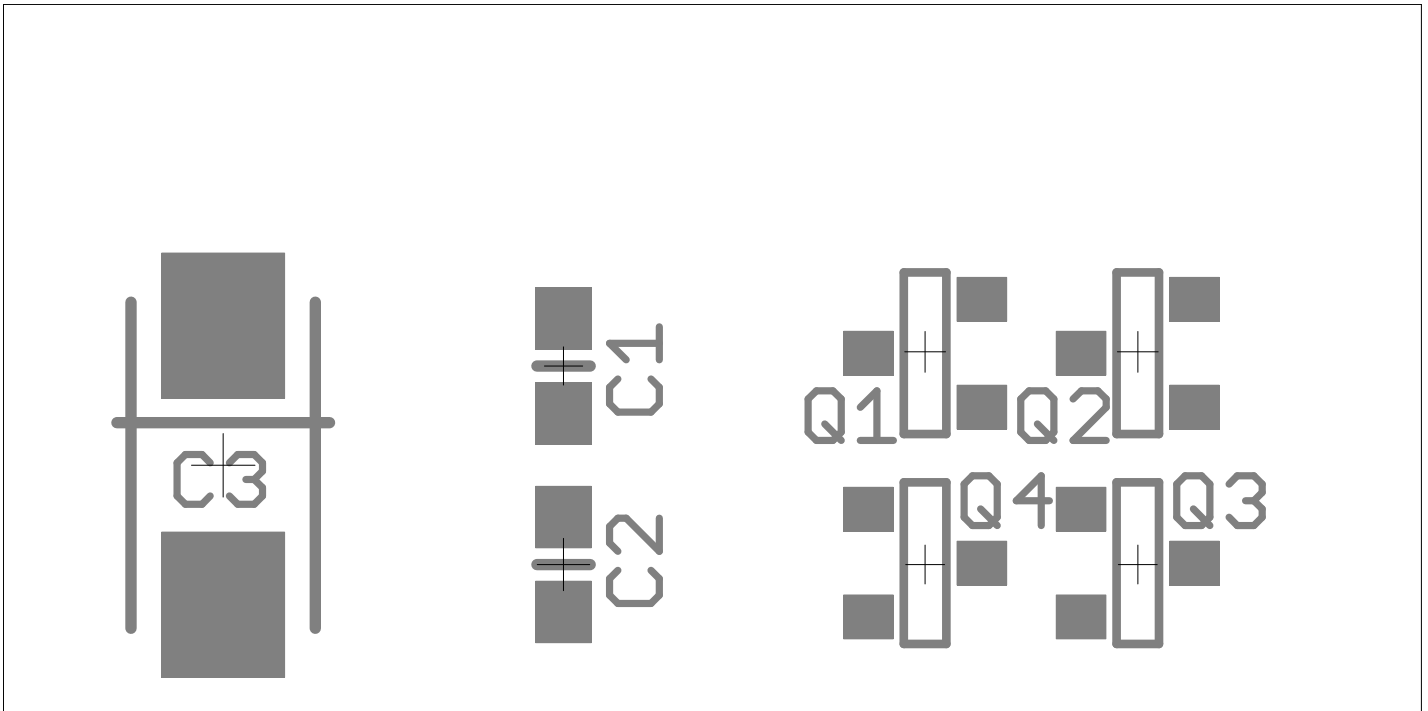

Top and Bottom Layers 1:1 Scale

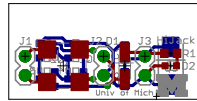

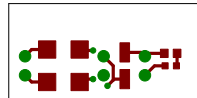

Bottom Copper Layer 1:1 Scale

